



Macurco™ Carbon Monoxide Detector, Controller and Transducer CM-6
User Instructions



Important: Keep these User Instructions for reference

TABLE OF CONTENTS	
GENERAL SAFETY INFORMATION	3
Intended Use	3
List of Warnings and Cautions	3
USE INSTRUCTIONS AND LIMITATIONS	4
Use For	4
Do Not Use For	4
General Description	4
Features	5
Specifications	5
INSTALLATION AND OPERATING INSTRUCTIONS	5
Location	6
Installation	6
Garage diagram	7
4-20 mA Output diagram	7
Multiple Device diagram	8
Alarm Control Panel diagram	8
DVP-120 Control Panel diagram	9
Alternate Alarm Panel	10
Power Up	10
Operation	10
Default - Factory Settings	10
Display setting	11
Buzzer setting	12
Alarm Relay setting	12
Alarm Relay Configuration	12
Fan Relay setting	12
Fan Relay Delay setting	12
Fan Minimum Runtime setting	13
Fan Relay Latching setting	13
4-20mA Output setting	13
On Board Diagnostics	13
Sensor Poisons	14
MAINTENANCE	14
End-of-Life Signal	14
Sensor Life Reset	14
Cleaning	15
Testing	15
Operation Test	15
Manual Operation Test	16
Carbon Monoxide Gas Test	17
Aerosol Carbon Monoxide Test	19
Field Calibration Procedure	19
MACURCO GAS DETECTION PRODUCTS WARRANTY	20

GENERAL SAFETY INFORMATION

Intended Use

The Macurco CM-6 is a low voltage, dual relay Carbon Monoxide (CO) detector, controller and transducer. The CM-6 has selectable 4-20 mA output, buzzer and digital display options. It is an electronic detection system used to measure the concentration of Carbon Monoxide and provide feedback and automatic exhaust fan control to help reduce CO concentrations in parking garages, maintenance facilities or other commercial applications. The CM-6 is a low level meter capable of displaying from 0-200 ppm (parts per million) of Carbon monoxide. The CM-6 is factory calibrated and 100% tested for proper operation, but can also be calibrated in the field.

List of Warnings and Cautions within these User Instructions



- Each person using this equipment must read and understand the information in these User Instructions before use. Use of this equipment by untrained or unqualified persons, or use that is not in accordance with these User Instructions, may adversely affect product performance and **result in sickness or death**.
- Use only for monitoring the gas which the sensor and instrument are designed to monitor. Failure to do so may result in exposures to gases not detectable and **cause sickness or death**. For proper use, see supervisor or User Instructions, or call Technical Service at 1-877-367-7891.
- This equipment may not function effectively below 0°F or above 125°F (-18°C or above 52°C). Using the detector outside of this temperature range may adversely affect product performance and **result in sickness or death**.
- This detector helps monitor for the presence and concentration level of a certain specified airborne gas. Misuse may produce an inaccurate reading, which means that higher levels of the gas being monitored may be present and could result in overexposure and **cause sickness or death**. For proper use, see supervisor or User Instructions, or call Technical Service at 1-877-367-7891.
- High voltage relay terminals (120/240 VAC) are located within this detector, presenting a hazard to service technicians. Only qualified technicians should open the detector case and service the internal circuits. Ensure power is removed from the detector relays prior to servicing the unit. **Failure to do so may result in sickness or death**.
- Do not disassemble unit or attempt to repair or modify any component of this instrument. This instrument contains no user serviceable parts, and substitution of components may impair product performance and **result in sickness or death**.
- Using a certified gas with a concentration other than the one listed for this detector when conducting a calibration or calibration verification test (bump test) will produce inaccurate readings. This means that higher levels of the gas being monitored may be present and could result in overexposure and **cause sickness or death**. For proper use, see supervisor or User Instructions, or call Technical Service at 1-877-367-7891
- The following steps must be performed when conducting a calibration or calibration verification test (bump test) to ensure proper performance of the monitor. Failure to do so may adversely affect product performance and **result in sickness or death**.
 - When performing a calibration or calibration verification test (bump test) only use certified calibration gas at the required concentration level. Do not calibrate with expired calibration gas.
 - If the instrument cannot be calibrated, do not use until the reason can be determined and corrected.
 - Do not cover or obstruct display or visual alarm cover.
 - Ensure sensor inlets are unobstructed and is free of debris

USE INSTRUCTIONS AND LIMITATIONS



Each person using this equipment must read and understand the information in these *User Instructions* before use. Use of this equipment by untrained or unqualified persons, or use that is not in accordance with these *User Instructions*, may adversely affect product performance and **result in sickness or death**.

Use For

The CM-6 provides CO detection and automatic exhaust fan control for automotive maintenance facilities, enclosed parking garages, utility rooms, warehouses and other commercial applications. The CM-6 meets the requirements of the Uniform Building Code for enclosed garages and meets OSHA standards for CO exposure. CM-6 can be used stand alone, with the Macurco DVP-120 Detection and Ventilation Control Panel, other 12 VAC or 24 VDC fire/security panels or building automation systems.



Use only for monitoring the gas which the sensor and instrument are designed to monitor. Failure to do so may result in exposures to gases not detectable and **cause sickness or death**. For proper use, see supervisor or *User Instructions*, or call Technical Service at 1-877-367-7891.

Do Not Use For

The CM-6 is not intended for use in hazardous locations or industrial applications such as refineries, chemical plants, etc. Do not mount the CM-6 where the normal ambient temperature is below 0°F or exceeds 125°F (-18°C or above 52°C). The CM-6 mounts on a type 4S electrical box supplied by the contractor. Do not install the CM-6 inside another box unless it has good air flow through it.



This equipment may not function effectively below 0°F or above 125°F (-18°C or above 52°C). Using the detector outside of this temperature range may adversely affect product performance and **result in sickness or death**.

General Description

The CM-6 is a low voltage, dual relay Carbon Monoxide (CO) detector and automatic ventilation controller. The CM-6 uses a microcomputer controlled, electronic system to measure the concentration of CO, actuate relays and provide a 4-20 mA output. The CM-6 has a low maintenance long life (7+ years) electrochemical sensor and optional gas test and calibration kits. The CM-6 is a low level meter capable of displaying from 0-200 ppm of carbon monoxide.

Features

- ETL Listed to UL 61010-1
- Low level meter capable of displaying from 0-200 ppm of CO
- The CM-6 meets the Uniform Building Code for enclosed garages and meets OSHA standards for CO exposure
- Selectable fan and alarm relay activation
- 5 A SPDT fan relay controls starters of exhaust fans
- 0.5 A N.O. or N.C. alarm relay connects to warning devices or control panels
- 4-20 mA Current Loop
- CM-6 mounts on a standard 4x4 electrical box and becomes cover for the box
- Supervised system: any internal detector problem will cause the fan & Alarm relay to activate
- Calibration kit is available. One screw allows access for calibration or gas test

Specifications

- Power: 3 W (max) from 12 to 24 VAC or 12 to 32 VDC
- Current @ 24 VDC: 75 mA in alarm (two relays), 50 mA (fan relay only) and 23 mA stand by
- Shipping Weight: 1 pound (0.45 kg)
- Size: 4 1/2 x 4 x 2 1/8 in. (11.4 X 11.4 X 5.3 cm)
- Color: Dark gray
- Connections: plugs/terminals
- Mounting box: (not included) 4x4 electric
- Fan relay: 5 A, 240 VAC, pilot duty, SPDT, latching or non-latching
- Fan relay actuation: selectable at diS (disable), 15 ppm, 25 ppm, 35 ppm (default), 50 ppm or 100 ppm CO
- Fan Delay Settings of 0, 1, 3 (default), 5 and 10 minutes
- Fan Minimum Runtime settings are 0 (default), 3, 5, 10 or 15 minutes
- Fan relay latching or not latching (default) selectable
- Alarm relay: 0.5A 120 V, 60 VA
- Alarm relay actuation: selectable N.O. default or N.C.
- Alarm relay settings: diS, 50 ppm, 100 ppm, 150 ppm and 200 ppm (default)
- Current Loop, 4-20 mA for 0-200 ppm CO. selectable to off or on (default)
- Buzzer: 85 dBA at 10cm settable to off (default) or on
- Digital display: 3 digit LED selectable to off (default) or on.
- Operating Environ: 0°F to 125° F (-18°C to 52°C).10 to 90% RH

INSTALLATION AND OPERATING INSTRUCTIONS

The following instructions are intended to serve as a guideline for the use of the Macurco CM-6 Carbon Monoxide Detector. It is not to be considered all-inclusive, nor is it intended to replace the policy and procedures for each facility. If you have any doubts about the applicability of the equipment to your situation, consult an industrial hygienist or call Technical Service at 1-877-367-7891.

 **WARNING**

This detector helps monitor for the presence and concentration level of a certain specified airborne gas. Misuse may produce an inaccurate reading, which means that higher levels of the gas being monitored may be present and could result in overexposure and **cause sickness or death**. For proper use, see supervisor or User Instructions, or call Technical Service at 1-877-367-7891.

Location

A CM-6 is normally mounted at breathing level, about 5 feet (1.5 meters) above the floor on a wall or column in a central area where air movement is generally good. The unit, on average, can cover about 5,000 sq. ft. (465 sq. meters). The coverage depends on air movement within the room or facility. Extra detectors may be needed near any areas where people work or where the air is stagnant. Do NOT mount the CM-6 where the normal ambient temperature is below 0°F or exceeds 125°F (below -18°C or above 52°C).

 **WARNING**

High voltage relay terminals (120/240 VAC) are located within this detector, presenting a hazard to service technicians. Only qualified technicians should open the detector case and service the internal circuits. Ensure power is removed from the detector relays prior to servicing the unit. **Failure to do so may result in sickness or death.**

Installation

1. The CM-6 mounts on a 4" square (or 4x4) electrical box supplied by the contractor. Do not mount the CM-6 inside another box, unless it has good air flow through it.
2. Connect the CM-6 to Class 2 power supply only. It is suggested to use a separate transformer for powering the unit or units because of possible interference's from other devices on the same power supply.
3. Connect the CM-6 to the control cables with terminal plugs. When making connections, make sure the power is off.
4. There are two terminals for Power: 12 to 24 VAC or 12 to 32 VDC, with no polarity preference.
5. There are two terminals for the dry alarm relay contacts, again with no polarity preference. The alarm relay can switch up to 0.5 A 120 V, or 60 VA. The alarm relay is activated if gas reaches or exceeds the alarm settings. See OPERATION section of these User Instructions for details on relay settings.
6. The alarm relay can be configured to normally open (default) (N.O.) or normally closed (N.C.) and will activate if the gas concentration exceeds alarm set point. It will deactivate once the gas concentration drops below the alarm set point. Note that the "disable" setting will cause the alarm relay not to engage at all.
7. The dry contact, SPDT fan relay has three terminals. The common (COM.), normally open (N.O.) and the normally closed (N.C.) contact. The fan relay can switch up to 5.0 A up to 240 VAC. See OPERATION section of these User Instructions for details on relay settings.

8. The Fan Relay can be configured for latching or non-latching (default) when activated (when the gas concentration exceeds fan relay set point). Once latched in, power will need to be interrupted or the "TEST" button pressed to un-latch the relay condition.
9. The Fan Relay will engage if the fan setting Carbon Monoxide concentration is exceeded for longer than the Fan Relay Delay time. Unless it is configured for latching, the fan relay will disengage once both of these conditions have been met:
 - Carbon Monoxide concentration has dropped below fan setting
 - Fan Relay Run time has been exceeded
 Note that the "disable" fan setting will cause the fan relay to not engage. The fan relay will engage in trouble fault condition and will disengage once trouble fault condition is cleared.
10. The Current Loop is 4 mA in clean air and 4-20 mA for 0-200ppm CO

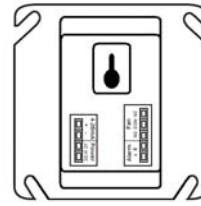
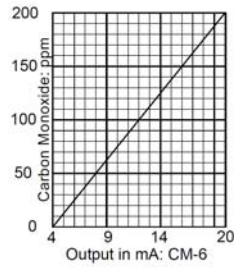

CM-6 rear view with Modular Connectors

Typical Installation in small garage

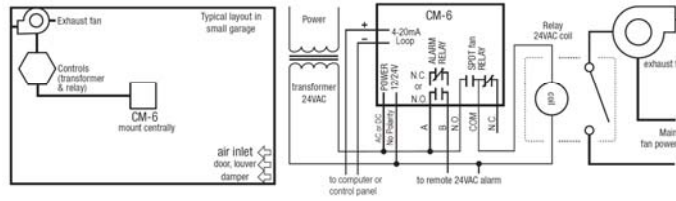

Typical multiple CM-6 installation

INSTALLATION NOTES

1. One sensor per 5000 square feet (approximately).
2. Mount CM-6 four to five feet above the floor.
3. See applicable building code for fan size vs air changes per periods of time.
4. Make sure there are air inlets to provide adequate air flow throughout the building.
5. CM-6 fan relays are dry contact & can switch up to 240V; see ratings, over.
6. Several fan relays (starters) may be used. Match the relays to the fan size.

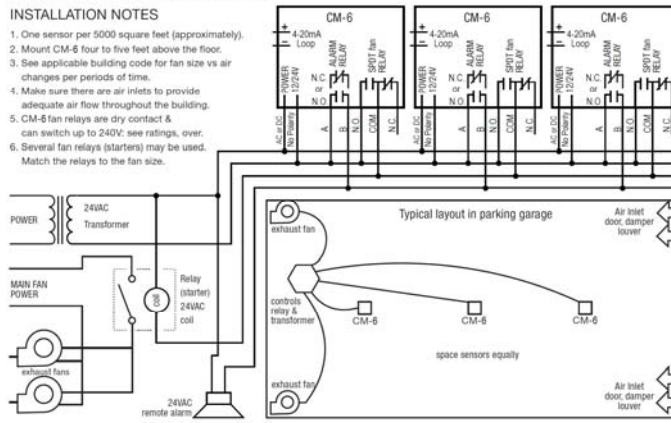

Typical Connection to Alarm Control Panel

1. CM-6 can be used with 12VDC or 24VDC N.O. (fire) panels.
2. Alarm panel provides battery backed up power to CM-6.
3. CM-6 dry contact fan relay can use panel power or fan power; check ratings.
4. Match fan relay contacts to fan size, and coil voltage to power source.
5. Alarm Control Panels are available with many features & can control other devices such as smoke detectors, fire detectors & burglar alarms.

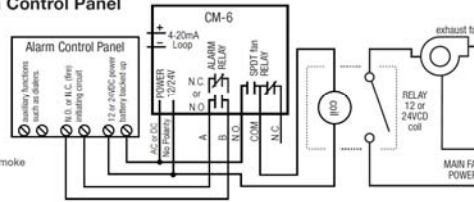

Typical connection to the Macurco DVP-120 Control Panel

Gas detection and exhaust fan control is provided by a Macurco DVP-120 system. This System will use the CM-6 Carbon Monoxide to current transducer, Nitrogen Dioxide to current transducers or Combustible Gas to current transducers. Each transducer will measure the level of the target gas and provide this information to the DVP-120 over a 4-to-20 mA current loop.

All power and signal connections for the transducers are provided from the DVP-120 control panel, via unshielded four conductor cable. The DVP-120 control panel provides three relays which can be used for ventilation fan control or alarm signaling. These relays (SPDT - Form C) are for pilot duty only, capable of switching 10 amp loads up to 240 VAC.

NOTE:
1. Power connections of the sensor are non-polarized.

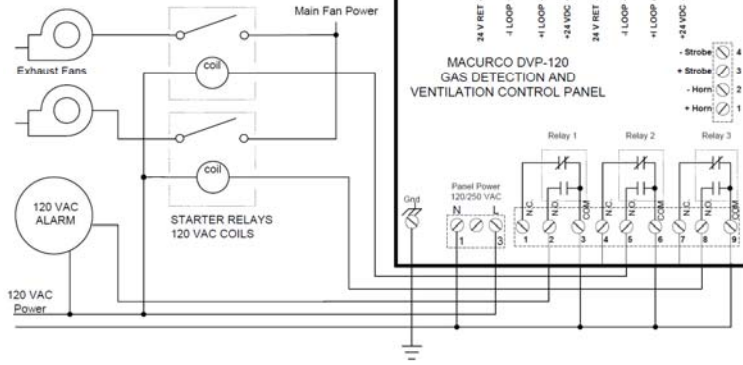

Alternate Connection to Alarm Control Panel

1. In this configuration the Fan or primary relay is used as a low level alarm relay. The Alarm or secondary relay is used as a supervisory relay when used in the normally closed option.
2. The CM-6 monitors all critical functions of the unit through software diagnostics that continuously test and verify unit operations. If a problem is found, the unit will switch to a fail-safe/error mode or trouble condition.
3. In this error mode the Fan and Alarm relays will be activated indicating a trouble condition at the panel and the CM-6 display will Flash the error.

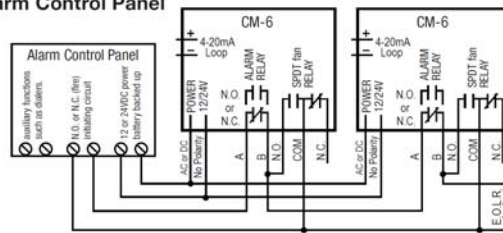

Power Up

The CM-6 cycles through an internal self-test cycle for the first minute that it is powered. The unit will execute the test cycle any time power is dropped and reapplied (i.e. power failure). During the self-test cycle the unit will display the firmware version number, then count down from 60 to 0 (if the display setting is "On") and finally go into normal operation. The alarm relay will be activated for 10 seconds and the fan relay for 60 seconds during the power-up cycle unless the "Power Up Test" (PUT) option is OFF. The indicator light (LED) will flash green during the self-test cycle. At the end of the 1 minute cycle, the unit will take its first sample of the air and the indicator light will turn solid green.

Operation

1. With the display function turned "On", the CM-6 will show the current concentration of CO ppm or "0" (zero) in clean air. When the CO concentration reaches the Fan Relay setting (35 ppm, for example) the display will flash back and forth between "FAn" and "35". With the display function turned "Off", the display does not show the CO concentration, but will show "FAn" as long as the fan relay is activated.
2. With the display function turned "On" and the CO concentration reaching the Alarm Relay setting, (200 ppm, for example) the display will flash back and forth between "ALr" and "200". The buzzer will sound indicating "Alarm" if the buzzer is turned "On". With the display function turned off the display does not show the CO concentration, but will show "ALr" when the Alarm relay is activated.
3. With the 4-20 mA function turned "On" and the CO concentration climbing, the 4-20 mA signal will ramp up corresponding to the concentration (0-200 ppm, for example). The display will show "FAn" and "ALr" and sound as outlined above.

Default Configuration – Factory Settings

- The default Power Up Test setting is On
- The default Display setting is Off

- The default **Buzzer** setting is Off
- The default **Alarm Relay Setting** is activation at 200 ppm
- The default **Alarm Relay Configuration** setting is Normally Open
- The default **Fan Relay Setting** is activation at 35 ppm
- The default **Fan Relay Delay** setting is 3 minutes
- The default **Fan Relay Runtime** setting is 0
- The default **Fan Relay Latching** condition is OFF
- The default **4-20mA Output** setting is On

To change settings, remove the Philips screw on the front of the CM-6. Pull off the front cover of the unit.

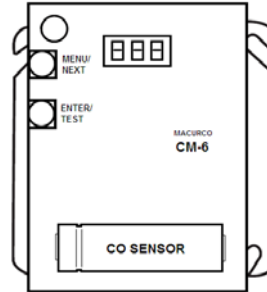

Selecting Default Configuration – “dEF”

To select the Default Configuration, in normal mode, push the *Next* button to get to “Con” or the Configuration menu. Then push the *Enter* button to enter the Con menu. The first selection is the “dEF” or Default setting. Push *Enter*. If it is already in Default configuration, there will be no action. If it is not already in Default configuration, “nO” will be displayed. Push *Next* to change it to “YES” (flashing) then push *Enter* to confirm the change (solid) and push *Enter* again to return to “dEF” in the con menu. Push *Next* until “End” is displayed then push *Enter* to get back to normal operation.

Selecting Power Up Test Option – “PU”

To select the **Power Up Test Configuration**, in normal mode, push the *Next* button to get to “Con” or the Configuration menu. Then push the *Enter* button to enter the Con menu. Then push the *Next* button to get to the **second selection** “PU” or **Power Up Test** setting. Push *Enter*. If the test is “On” push *Next* to turn it “OFF” (flashing) then push *Enter* to confirm the change (solid) and push *Enter* again to return to “PU” in the Con menu. Push *Next* until “End” is displayed then push *Enter* to get back to normal operation.

Selecting Display Option – “dSP”

To select the **Display Configuration**, in normal mode, push the *Next* button to get to “Con” or the Configuration menu. Then push the *Enter* button to enter the Con menu. Then push the *Next* button to get to the **third selection** “dSP” or Display setting. Push *Enter*. If the display is “On” push *Next* to turn it “OFF” (flashing) then push *Enter* to confirm the change (solid) and push *Enter* again to return to “dSP” in the Con menu. Push *Next* until “End” is displayed then push *Enter* to get back to normal operation.

Selecting Buzzer Option – “bUZ”

To select the **Buzzer Configuration**, in normal mode, push the *Next* button to get to “Con” or the Configuration menu. Then push the *Enter* button to enter the Con menu. **The fourth selection** is the “bUZ” or Buzzer setting. Push *Next* twice to get to “bUZ” then *Enter*. If the display is “On” push *Next* to turn it “OFF” (flashing) then push *Enter* to confirm the change (solid) and push *Enter* again to return to “bUZ” in the Con menu. Push *Next* until “End” is displayed then push *Enter* to get back to normal operation.

Selecting Alarm Relay Setting – “ArS”

To select the **Alarm Relay Setting**, in normal mode, push the *Next* button to get to “Con” or the Configuration menu. Then push the *Enter* button to enter the Con menu. **The fifth selection** is the “ArS” or Alarm Relay Setting. Push *Next* three times to get to “ArS” then *Enter*. If the display is “OFF” (disabled) push *Next* to change it to 50, 100, 150 or 200 ppm (flashing) then push *Enter* to confirm the change (solid) and push *Enter* again to return to “ArS” in the Con menu. Push *Next* until “End” is displayed then push *Enter* to get back to normal operation.

Selecting Alarm Relay Configuration – “Arc”

To select the **Alarm Relay Configuration**, in normal mode, push the *Next* button to get to “Con” or the Configuration menu. Then push the *Enter* button to enter the Con menu. **The sixth selection** is the “Arc” or Alarm Relay Configuration. Push *Next* four times to get to “Arc” then *Enter*. If the relay is “nO” (normally open) push *Next* to turn it to “nC” (flashing) then push *Enter* to confirm the change (solid) and push *Enter* again to return to “Arc” in the Con menu. Push *Next* until “End” is displayed then push *Enter* to get back to normal operation.

Selecting Fan Relay Settings – “FrS”

To select the **Fan Relay setting**, in normal mode, push the *Next* button to get to “Con” or the Configuration menu. Then push the *Enter* button to enter the Con menu. **The seventh selection** is the “FrS” or Fan Relay setting. Push *Next* five times to get to “FrS” then *Enter*. If the fan relay is “OFF” (disabled) push *Next* to change it to 15, 25, 35, 50 or 100 ppm (flashing) then push *Enter* to confirm the change (solid) and push *Enter* again to return to “run” in the Con menu. Push *Next* until “End” is displayed then push *Enter* to get back to normal operation.

Selecting Fan Relay Delay – “Frd”

To select the Fan Relay Delay setting, in normal mode, push the *Next* button to get to “Con” or the Configuration menu. Then push the *Enter* button to enter the Con menu. **The eighth selection** is the “Frd” or Fan Relay Delay. Push *Next* six times to get to “Frd” then *Enter*. If the delay is “OFF” (disabled) push *Next* to change it to 1, 3, 5, or 10 minutes (flashing) then push *Enter* to confirm the change (solid) and push *Enter* again to return to “Frd” in the Con menu. Push *Next* until “End” is displayed then push *Enter* to get back to normal operation.

Selecting Fan Relay Runtime – “Frr”

To select the Fan Minimum Runtime setting, in normal mode, push the *Next* button to get to “Con” or the Configuration menu. Then push the *Enter* button to enter the Con menu. **The ninth selection** is the “Frr” or Fan Minimum Run Time. Push *Next* seven times to get to “Frr” then *Enter*. If the runtime is “OFF” (disabled) push *Next* to change it to 3, 5, 10 or 15 minutes (flashing) then push *Enter* to confirm the change (solid) and push *Enter* again to return to “run” in the Con menu. Push *Next* until “End” is displayed then push *Enter* to get back to normal operation.

Selecting Fan Relay Latching Option – “FrL”

To select the **Fan Relay Latching Option**, in normal mode, push the *Next* button to get to “Con” or the Configuration menu. Then push the *Enter* button to enter the Con menu. **The tenth selection** is the “FrL” or Fan Relay Latching Option. Push *Next* nine times to get to “FrL” then *Enter*. If latching is “OFF” push *Next* to turn it to “ON” (flashing) then push *Enter* to confirm the change (solid) and push *Enter* again to return to “FrL” in the Con menu. Push *Next* until “End” is displayed then push *Enter* to get back to normal operation.

Selecting 4-20mA Output Option – “420”

To select the **4-20mA Output Option**, in normal mode, push the *Next* button to get to “Con” or the Configuration menu. Then push the *Enter* button to enter the Con menu. **The eleventh selection** is the “420” or 4-20mA Output Option. Push *Next* ten times to get to “420” then *Enter*. If the 4-20mA is “On” push *Next* to turn it to “OFF” (flashing) then push *Enter* to confirm the change (solid) and push *Enter* again to return to “420” in the Con menu. Push *Next* until “End” is displayed then push *Enter* to get back to normal operation.

Onboard Diagnostics

The CM-6 monitors all critical functions of the unit through software diagnostics that continuously test and verify unit operations. If a problem is found, the unit will switch to a fail-safe/error mode or trouble condition. In this error mode, the Fan and Alarm relays will be activated, the 4-20 mA current loop will go to 24 mA, the unit will display the error code and the buzzer will chirp intermittently. This is a safety precaution. To clear this mode, simply turn off power to the unit for a few seconds, or push the ENTER/TEST switch (inside the unit). This will cause the unit to restart the 1 minute self-test cycle.

The 4-20 mA signal can be used for troubleshooting:

- 0 mA is most likely a connection problem
- 4-20 mA is normal gas reading range (0-200 ppm)
- 24 mA indicates a Trouble condition

Error Codes

- 101 Sensor is missing
- 102 Temperature compensation failed
- 104 Bad EEPROM checksum
- 108 Sensor is shorted
- 110 Bad EEPROM
- 120 Bad calibration
- 140 Factory calibration was not done
- 180 ADC reading failed
- 1100 Under range sensor
- 1200 Sensor expired

NOTE: For trouble codes over 080 the display will alternate between L_1 and 100 for 1100 and between L_2 and 100 for 1200.

If the error mode repeats frequently, check for continuous power and proper voltage. If power is not the problem and a unit has repeating error conditions, it may need to be returned to Macurco for service, per these User Instructions.

If the error mode indicates "Sensor expired" see the **Sensor Life Reset** section of these User Instructions.

Sensor Poisons

The gas sensor in the detector is designed with extreme sensitivity to the environment. As a result, the sensing function may be deteriorated if it is exposed to contaminants, a direct spray from aerosols such as paints, silicone vapors, etc., or to a high density of corrosive gases (such as hydrogen sulfide, sulfur dioxide) for an extended period of time.

MAINTENANCE

The CM-6 does not require regular maintenance. The unit uses a long life electrochemical sensor that has a 7 year life expectancy (in normal conditions). All maintenance and repair of products manufactured by Macurco are to be performed at the appropriate Macurco manufacturing facility. Macurco does not sanction any third-party repair facilities.

End-of-life Signal

The CM-6 has a long life, non-replaceable electrochemical sensor. Seven (7) years after the CM-6 is installed the sensor end-of-life signal will be activated indicating that the CM-6 has reached the end of its typical usable life. The end-of-life signal will cause an error code 1200 "Sensor expired". See Error Codes section. The end-of-life signal can be silenced for 48 hours by pressing the "ENTER/TEST" button or by temporarily dropping power to the unit. The end-of-life signal provides the user an opportunity to test and/or calibrate the sensor assuring that it is still performing within acceptable parameters though the sensor is nearing the end of its

expected life. The silence function will continue to be available for 29 days after the CM-6 initiates the initial end-of-life signal. After this 29 day period the CM-6 can no longer be silenced and the sensor must be calibrated and the sensor life reset or the CM-6 detector replaced.

Sensor Life Reset

1. Remove the Phillips screw on the front of the CM-6. Pull the front cover of the unit off.
2. To reset the sensor life (rSt), from normal or warm-up mode, press the Next button four times to get to "SEn" or Sensor Mode.
3. Then press the Enter button to get to "rSt" - Reset Sensor Mode.
4. Press the Enter button again to see the sensor reset status. If the sensor life has already been reset, done "don" will be displayed. If it has not already been reset, "no" will be displayed. Push Next to change it to "YES" (flashing) then push Enter to confirm the change (solid) and push Enter again to return to "rSt" in the "SEn" menu. Push Next until "End" is displayed then push Enter to get back to normal operation. The sensor life will be reset for 1 year.

NOTE: If the sensor is reset and the detector not replaced, it is necessary to test and/or calibrate the sensor to assure that it is still performing within acceptable specifications though the sensor is nearing the end of its expected life. There will be no other indication of sensor performance.

WARNING

Do not disassemble unit or attempt to repair or modify any component of this instrument. This instrument contains no user serviceable parts, and substitution of components may impair intrinsic safety, which may adversely affect product performance and **result in sickness or death.**

CAUTION

Avoid the use of harsh cleaning materials, abrasives and other organic solvents. Such materials may permanently scratch the surfaces and damage the display window, labels, sensor or instrument housing.

Cleaning

Cleaning of the external surfaces is best carried out using a damp cloth with a mild detergent or soap. Use a vacuum cleaner with soft brush to remove dust or contamination under the cover. Do not blow out the sensor with compressed air.

TESTING

WARNING

Using a certified gas with a concentration other than the one listed for this detector when conducting a calibration or calibration verification test (bump test) will produce inaccurate readings. This means that higher levels of the gas being monitored may be present and could result in overexposure and **cause sickness or death.** For proper use, see supervisor or User Instructions, or call Technical Service at 1-877-367-7891.

General

All CM-6 units are factory calibrated and 100% tested for proper operation. The unit also performs a regular automatic self-test during normal operation. If the unit detects an improper voltage or inoperable component, it will default into Error mode. In this error mode, the Fan and Alarm relays will be activated, the 4-20 mA output will go to 24 mA, the unit will display the error code and the buzzer will chirp intermittently.

Operation Test

Normally this will be the only test required for the CM-6 and is the recommended way to test the unit or units after installation. Check that the green CM-6 operating LED light is illuminated continuously. If not, do not proceed with the tests. If the unit is in error mode contact your local representative or Macurco technical service representative for information on resolving the problem.

1. Remove the single screw in the middle of the front cover of the CM-6.
2. Remove the front cover.
3. Observe the LED light on the front of the CM-6.
4. If the light is solid green proceed to step 6.
5. If the light is off or flashing Green, refer to the General section above.
6. Locate the switch labeled ENTER/TEST on the left side of the printed circuit board. Press the Test switch once.
7. The CM-6 will step through a cycle test:
 - a. The display progresses through the **BUZ** (Buzzer Test) **Art** (alarm relay test), **Frt** (fan relay test) then **42t** (4-20 mA output test). Make sure that the settings are "on" or not disabled "dis".
 - b. During the first 10 seconds of the test cycle, the display will show BUZ and set off the audible buzzer
 - c. The alarm relay will be closed, so any devices connected to that relay will be tested.
 - d. The Fan relay will be activated for the next 1 minute of the test, so if the fan circuits are wired in the normal manner, the fan should run.
 - e. The 4-20mA output will then ramp up from 4 to 16 mA over the next 130 seconds of the test, so if the circuit is wired in the normal manner, the control panel or building automation system should respond.
 - f. At the end of the test cycle, the light will turn green and be on steady (Normal Operation), the fan & alarm relay will be in standby mode and the 4-20 mA output will return to 4 mA (in clean air).
8. When testing is completed reassemble the unit or units.

Manual Operation Test

This option gives the user the opportunity to manually initiate an individual test for each relay, the analog output and the sensor response to gas. From normal operation mode press the **Next** button 3 times to get to the Test Mode (TS). Press the **Enter** button once to get into the Test Menu. Press the **Next** button to scroll through the four test options and press **Enter** to initiate the selected test. Note that if the relay or 4-20 mA output has been disabled, the test selection will not be displayed in the test menu.

Art - Alarm Relay Test, 10 seconds

Frt - Fan Relay Test, 60 seconds

42t - 420 loop test, 25 seconds

gS - Gas Test, 3 minutes (no output to the panel during the gas test)

The display will flash during the test, or in the case of the gas test, the gas level will alternate with gIS. Once the test is complete, the display will return to steady display. To exit the test menu, press the **Next** button until "End" is displayed then, press **Enter** to return to normal mode.

Carbon Monoxide Gas Test



The following steps must be performed when conducting a calibration or calibration verification test (bump test) to ensure proper performance of the monitor. Failure to do so may adversely affect product performance and **result in sickness or death**.

- When performing a calibration or calibration verification test (bump test) only use certified calibration gas at the required concentration level. Do not calibrate with expired calibration gas.
- If the instrument cannot be calibrated, do not use until the reason can be determined and corrected.
- Do not cover or obstruct display or visual alarm cover.
- Ensure sensor inlets are unobstructed and is free of debris

General

A Field Calibration Kit, CM6-FCK, is needed to complete a CO gas test. These are available through your local representative or from Macurco.

Contents of the FCK

- CM6-FCK: (2) Gas Cylinders, (1) 17L 50ppm carbon monoxide (CO) in air and (1) 17L 200 ppm carbon monoxide (CO) in air
- Gas regulator with about two feet of plastic tubing
- Humidifier
- CM-6-CH calibration hood

FCK Information

Several detectors can be calibrated with one FCK. The only limitation is the amount of gas in the cylinder. The 17 liter cylinder has approximately 85 minutes of continuous calibration run time. Replacement cylinders are available. The gas cylinder should be replaced when the pressure gauge on the regulator shows 25-psi or less.

Note: For optimum test results it is suggested that the unit be in clean air, green light on, and be in a low ambient air flow

Gas Testing

Testing the Fan Relay

1. Remove the Philips screw on the front of the CM-6. Remove the front cover.
2. Open the FCK. Connect the 50 ppm gas cylinder to the regulator.
3. Check the pressure gauge on the regulator. If you have 25-psi or less you will need to replace the gas canister.
4. Assemble regulator, hose and Test Hood and place the Test Hood over the CO sensor.

Note: The time to activate the Fan relay depends on the delay setting.

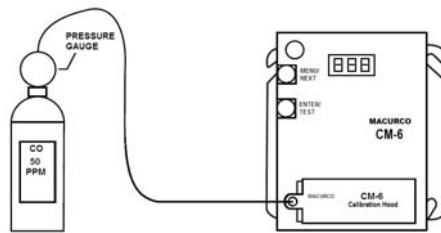

5. Turn on the regulator to start the gas flow and wait with the gas applied continuously.
6. With the display function turned "On", the CM-6 will show the current concentration of CO or "0" (zero) in clean air. When the CO concentration reaches the Fan Relay setting (35 ppm, for example) the display will flash back and forth between "FAn" and "35". With the display function turned "Off", the display does not show the CO concentration, but will show "FAn" as long as the fan relay is activated.

Note: If the Fan relay does not close within 2 minutes, there are four possibilities:

- a. Gas cylinder is empty, check the pressure gauge. Replace the gas cylinder if 25psi or less.
- b. Unit needs to be re-calibrated (go through recalibration and re-test).
- c. Detector is in need of servicing (return unit to factory for servicing).
- d. Detector has fan relay set to disable (OFF) or 100ppm. Set fan relay to 25ppm and repeat the test.

7. Remove the gas from the sensor. Proceed to Test the Alarm relay or replace the top cover.

Testing the Alarm Relay

Note: The CO concentration to activate the Alarm relay depends on the setting.

1. Connect the 200ppm cylinder of carbon monoxide to the regulator.
2. Check the pressure gauge. If there is 25psi or less the cylinder should be replaced.
3. Place the Test Hood over the CO sensor. Turn on the regulator to start the gas flow.
4. The Fan relay should activate according to the settings.
5. With the display function turned "On" and the CO concentration reaching the Alarm Relay setting, (200 ppm, for example) the display will flash back and forth between "ALr" and "200". The buzzer will sound indicating "Alarm" if the buzzer is turned "On". With the display function turned off the display does not show the CO concentration, but will show "ALr" when the Alarm relay is activated.

Note: If the Alarm relay fails to operate within 2 minutes, there are four possibilities:

- a. Gas cylinder is empty, check the pressure gauge. Replace the gas cylinder if 25-psi or less.
- b. Unit needs to be re-calibrated (go through recalibration and re-test).
- c. Detector is in need of servicing (return unit to factory for servicing).
- d. Detector has Alarm relay set to disable (OFF). Set Alarm relay to 100 ppm and repeat the test.

6. Remove the gas from the sensor after Test. Proceed to Test the 4-20mA output or replace the top cover.

Testing the 4-20mA current loop

1. Connect the 200 ppm cylinder of carbon monoxide to the regulator.
2. Check the pressure gauge. If there is 25-psi or less the cylinder should be replaced.
3. Place the cap from the regulator over the CO sensor. Turn on the regulator to start the gas flow.
4. The Fan relay should activate according to the settings.
5. The Alarm relay should activate according to the settings.
6. The 4-20 mA output should ramp up from 4mA in clean air to 20mA at 200 ppm. See 4-20 mA diagram on page 6.

Note: If the 4-20mA output does not ramp up within 2 minutes, there are four possibilities:

- a. Gas cylinder is empty, check the pressure gauge. Replace the gas cylinder if 25-psi or less.
 - b. Unit needs to be re-calibrated (go through recalibration and re-test).
 - c. Detector is in need of servicing (return unit to factory for servicing).
 - d. Detector has 4-20 mA option set to "OFF". Set 4-20mA option to "On" and repeat the test.
7. Remove the gas from the sensor. Re-assemble the CM-6 (make sure the LED is aligned with the front case hole). You are done.

Aerosol Carbon Monoxide Test

The CME1-FTG is an 11L 500 ppm Aerosol Carbon Monoxide Field Test Gas that can be used with the CM-6. This field test gas allows installers to do a quick functionality test of the CO sensor. The flow rate of the CME1-FTG is 10 Lpm so you will have about a minute of gas or enough to test 20-30 sensors.

1. Units to be tested must be powered continuously for a minimum of 3 minutes before proceeding.
2. For optimum test results the unit should be in clean air and be in a low ambient air flow.
3. Check that the CM-6 status indicator light is illuminated, Green continuously. If not, do not proceed with tests. See CM-6 Onboard Diagnostics section.
4. The display option should be set to "On" and reading 0 ppm in clean air.
5. With the CM-6 cover on, aim the nozzle of the aerosol can into the sensor grate area (under DO NOT PAINT) and press for 2 to 3 seconds.
6. Wait for a few seconds. The digital display should climb indicating the increased CO concentration at the sensor confirming a pass of the quick test.

Note: If the Display does not change within 10 seconds, there are four possibilities:

- a. Gas cylinder is empty, replace the gas cylinder.
 - b. Unit needs to be re-calibrated (go through the Field Calibration Procedure and re-test).
 - c. Detector is in need of servicing (return unit to factory for servicing).
7. Wait for the display to return to 0 ppm and configure options to desired settings.

FIELD CALIBRATION PROCEDURE

Note: For optimum calibration results the unit should be in clean air and be in a low ambient air flow.

1. Remove the Phillips screw on the front of the CM-6. Pull the front cover of the unit off.

2. Assemble the 200 ppm gas cylinder and regulator together.
3. Check the pressure gauge on the regulator. If you have 25-psi or less you will need to replace the gas canister.
4. Place the test Hood from the regulator over the CO sensor.
5. Push **Next** 3 times to get to the CAL menu then push **Enter**. The display will flash back and forth between GAS and 200.
6. Start applying gas to the CO sensor.
Note: The sensor will look for the gas for 45 seconds. If no gas is applied or detected in that time, the display will return to CAL.
7. When the sensor detects the gas, the display will flash back and forth between the CO concentration and **SPn**, then the calibration will progress and the display will show the gas level for a maximum of 165 seconds.
8. When the calibration is successful, the display will flash back and forth between CO concentration and **PAS**, then the display will show the calibration gas level and the calibration is done.
9. If the calibration fails, the display will flash back and forth between the CO concentration and **FAL** (fail). If this occurs, check the pressure gauge on the regulator. If the pressure is less than 25 psi the flow of gas may not be adequate to properly calibrate the unit. If there is proper pressure in the cylinder repeat steps 4 through 6. If the unit fails to calibrate twice contact Technical Assistance: 1-877-367-7891.
10. Once the calibration has passed, remove gas and disassemble the cylinder and regulator.
11. Re-assemble the CM-6 (make sure the LED is aligned with the front case hole). You are done.
12. See Calibration Flowchart on the inside of the housing.

MACURCO FIXED GAS DETECTION PRODUCTS LIMITED WARRANTY

Macurco warrants the CM-6 gas detector will be free from defective materials and workmanship for a period of two (2) years from date of manufacture (indicated on the inside cover of the CM-6), provided it is maintained and used in accordance with Macurco instructions and/or recommendations. If any component becomes defective during the warranty period, it will be replaced or repaired free of charge, if the unit is returned in accordance with the instructions below. This warranty does not apply to units that have been altered or had repair attempted, or that have been subjected to abuse, accidental or otherwise. The above warranty is in lieu of all other express warranties, obligations or liabilities. THE IMPLIED WARRANTIES OF MERCHANTABILITY AND FITNESS FOR PARTICULAR PURPOSE ARE LIMITED TO A PERIOD OF TWO (2) YEARS FROM THE PURCHASE DATE. Macurco shall not be liable for any incidental or consequential damages for breach of this or any other warranty, express or implied, arising out of or related to the use of said gas detector. Manufacturer or its agent's liability shall be limited to replacement or repair as set forth above. Buyer's sole and exclusive remedies are return of the goods and repayment of the price, or repair and replacement of non-conforming goods or parts.

Manufactured by Aerionics, Inc.
Round Rock, Texas
Email: info@aerionicsinc.com
Phone: 1-877-367-7891
Rev 8.14.2013
© Aerionics 2013. All rights reserved.
Macurco is a trademark of Aerionics, Inc.

